

## 12N60F

### 12 Amps,600 Volts N-CHANNEL Power MOSFET

#### FEATURE

- 12A,600V, $R_{DS(ON)MAX}=0.75\ \Omega$  @ $V_{GS}=10V/6A$
- Low gate charge
- Low  $C_{iss}$
- Fast switching
- 100% avalanche tested
- Improved dv/dt capability

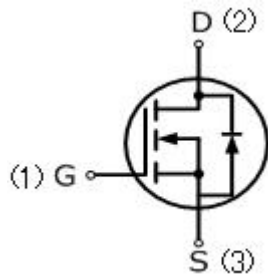

#### TO-220F-3L

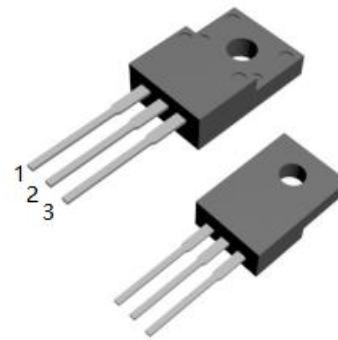

#### Absolute Maximum Ratings ( $T_C=25^\circ\text{C}$ , unless otherwise noted)

Parameter	Symbol	12N60F	UNIT
Drain-Source Voltage	$V_{DSS}$	600	V
Gate-Source Voltage	$V_{GS}$	$\pm 30$	
Continuous Drain Current	$I_D$	12	A
Pulsed Drain Current(Note1)	$I_{DM}$	48	
Single Pulse Avalanche Energy (Note 2)	$E_{AS}$	545	mJ
Reverse Diode dV/dt (Note 3)	dv/dt	5	V/ns
Operating Junction and Storage Temperature Range	$T_J, T_{STG}$	-55to+150	$^\circ\text{C}$
Maximum lead temperature for soldering purposes, 1/8" from case for 5 seconds	$T_L$	260	$^\circ\text{C}$

#### Thermal Characteristics

Parameter	Symbol	12N60F	Units
Thermal resistance , Channel to Case	$R_{th(ch-c)}$	2.98	$^\circ\text{C}/\text{W}$
Maximum Power Dissipation	$T_C=25^\circ\text{C}$ $P_D$	42	W

<b>Electrical Characteristics (<math>T_c=25^\circ\text{C}</math>, unless otherwise noted)</b>						
<b>Parameter</b>	<b>Symbol</b>	<b>Test Conditions</b>	<b>Min</b>	<b>Typ</b>	<b>Max</b>	<b>Units</b>
<b>Off Characteristics</b>						
Drain-Source Breakdown Voltage	$BV_{DSS}$	$V_{GS}=0V, I_D=250\mu A$	600	—	—	V
Zero Gate Voltage Drain Current	$I_{DSS}$	$V_{DS}=600V, V_{GS}=0V$	—	—	1	$\mu A$
Gate-Body Leakage Current, Forward	$I_{GSSF}$	$V_{GS}=30V, V_{DS}=0V$	—	—	100	nA
Gate-Body Leakage Current, Reverse	$I_{GSSR}$	$V_{GS}=-30V, V_{DS}=0V$	—	—	-100	nA
<b>On Characteristics</b>						
Gate-Source Threshold Voltage	$V_{GS(th)}$	$V_{DS}=V_{GS}, I_D=250\mu A$	2	—	4	V
Drain-Source On-State Resistance	$R_{DS(on)}$	$V_{GS}=10V, I_D=6A$	—	0.51	0.75	$\Omega$
<b>Dynamic Characteristics</b>						
Input Capacitance	$C_{iss}$	$V_{DS}=25V, V_{GS}=0V,$ $f=1.0\text{MHz}$	—	2066	—	pF
Output Capacitance	$C_{oss}$		—	135	—	pF
Reverse Transfer Capacitance	$C_{rss}$		—	92	—	pF
<b>Switching Characteristics</b>						
Turn-On Delay Time	$t_{d(on)}$	$V_{DD}=300V, I_D=12A,$ $R_G=10\Omega$	—	19.2	—	ns
Turn-On Rise Time	$t_r$		—	2.8	—	ns
Turn-Off Delay Time	$t_{d(off)}$		—	63.2	—	ns
Turn-Off Fall Time	$t_f$		—	33.2	—	ns
Total Gate Charge	$Q_g$	$V_{DS}=480V, I_D=12A,$ $V_{GS}=10V$	—	37.9	—	nC
Gate-Source Charge	$Q_{gs}$		—	9.5	—	nC
Gate-Drain Charge	$Q_{gd}$		—	9.2	—	nC
<b>Drain-Source Body Diode Characteristics and Maximum Ratings</b>						
Diode Forward Voltage	$V_{SD}$	$I_S=12A, V_{GS}=0V$	—	—	1.5	V
Reverse Recovery Time	$t_{rr}$	$V_{DS}=30V, I_S=1A,$ $dI_F/dt=100A/\mu s, (\text{Note3})$	—	156	—	ns
Reverse Recovery Charge	$Q_{rr}$		—	584.8	—	nC

**Notes**

1. Repetitive Rating: pulse width limited by maximum junction temperature.
2.  $V_{DD}=50V, L=10\text{mH}, R_g=25\Omega$ , starting  $T_J=25^\circ\text{C}$ .
3. Pulse width  $\leq 300\mu s$ ; duty cycle  $\leq 2\%$ .

## RATING AND CHARACTERISTIC CURVES



Peak Diode Recovery  $dv/dt$  Test Circuit



Peak Diode Recovery  $dv/dt$  Waveforms



**Switching Test Circuit**



**Switching Waveforms**



**Gate Charge Test Circuit**



**Gate Charge Waveform**



**Unclamped Inductive Switching Test Circuit**



**Unclamped Inductive Switching Waveforms**

## RATING AND CHARACTERISTIC CURVES

Figure.1 Typical Output Characteristics

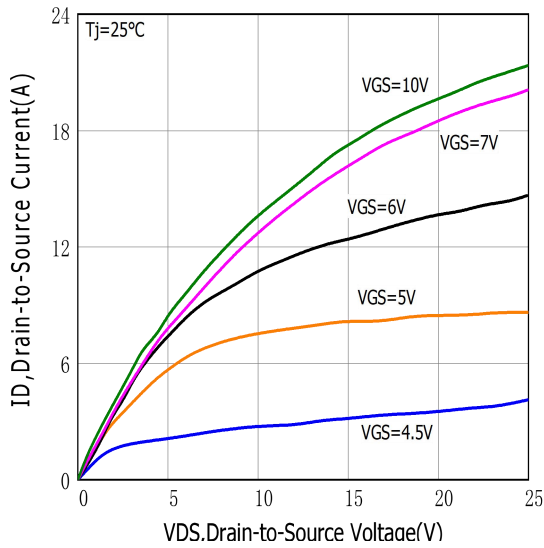

Figure.2 Typical Gate Charge vs Gate to Source Voltage

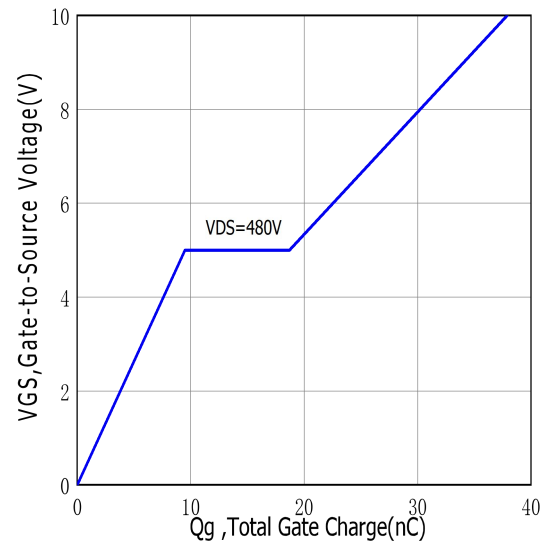

Figure.3 Typical Body Diode Transfer Characteristics

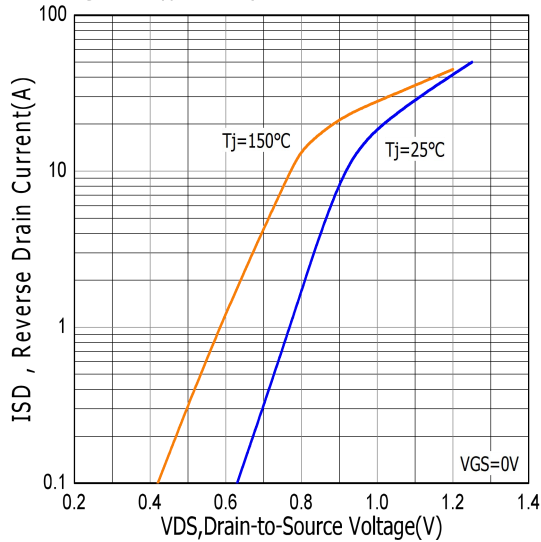

Figure.4 Typical Capacitance vs Drain to Source Voltage

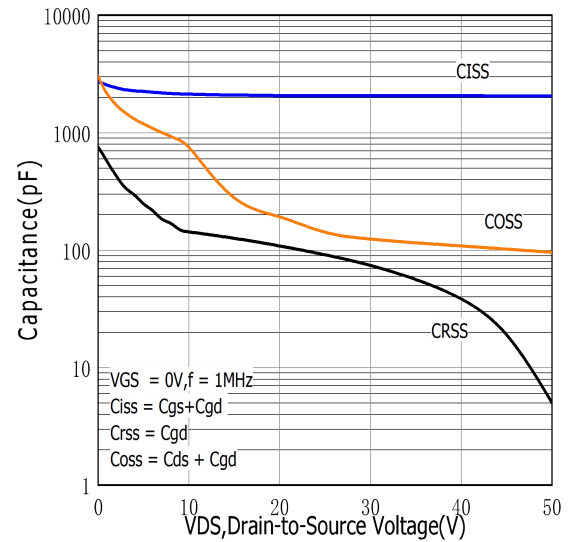

Figure.5 Typical Breakdown Voltage vs Junction Temperature

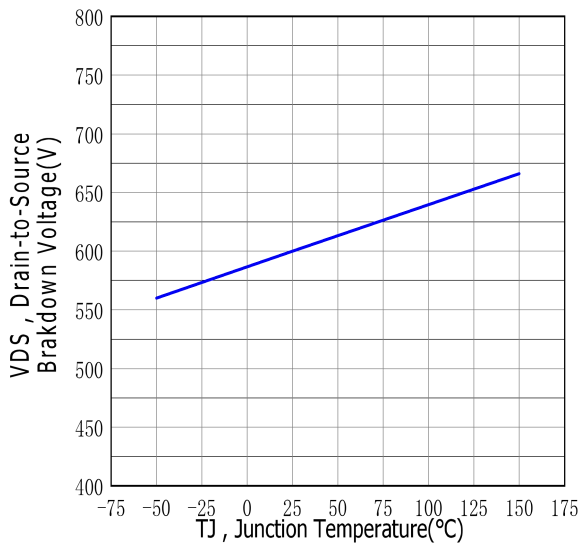

Figure.6 Typical Drain to Source on Resistance vs Junction Temperature

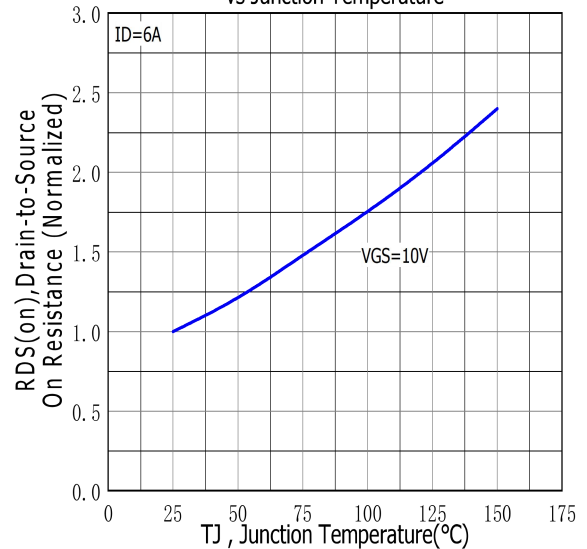

Figure.7 Maximum Forward Bias Safe Operating Area

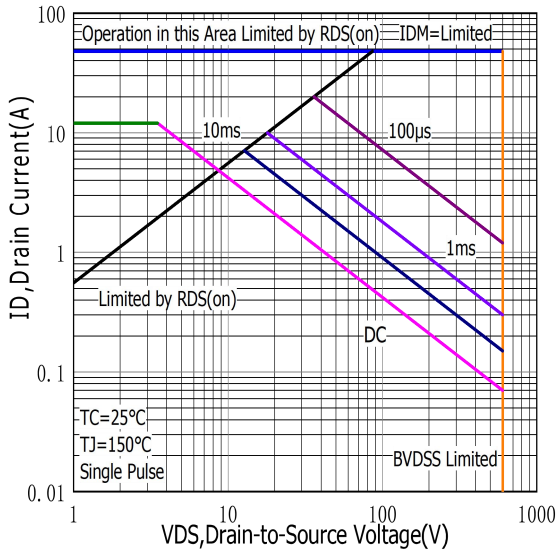

Figure.8 Typical Drain to Source ON Resistance vs Drain Current

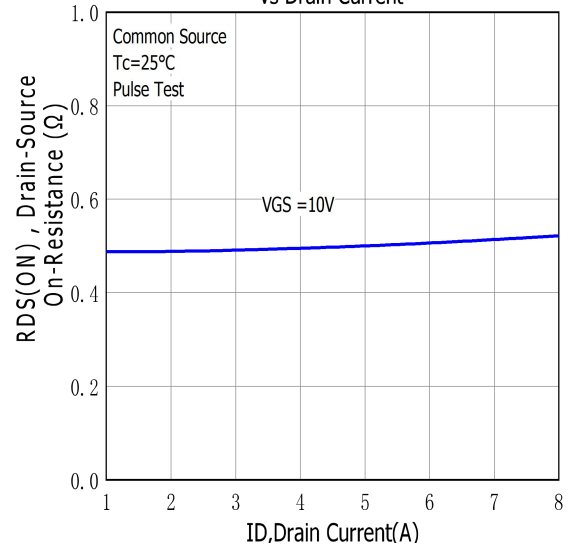

Figure.9 Maximum EAS vs Channel Temperature

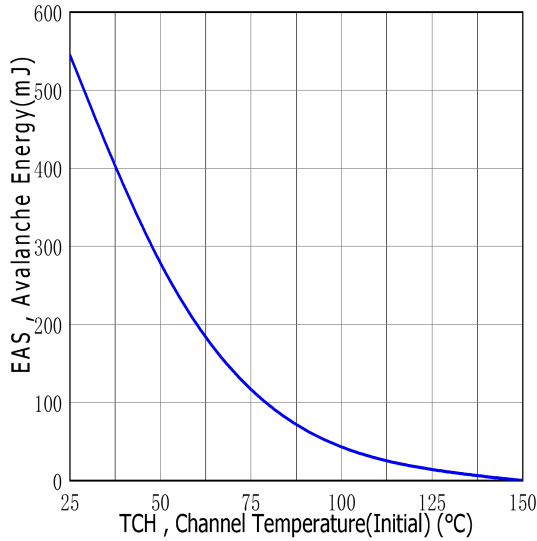

Figure.10 Typical Threshold Voltage vs Case Temperature

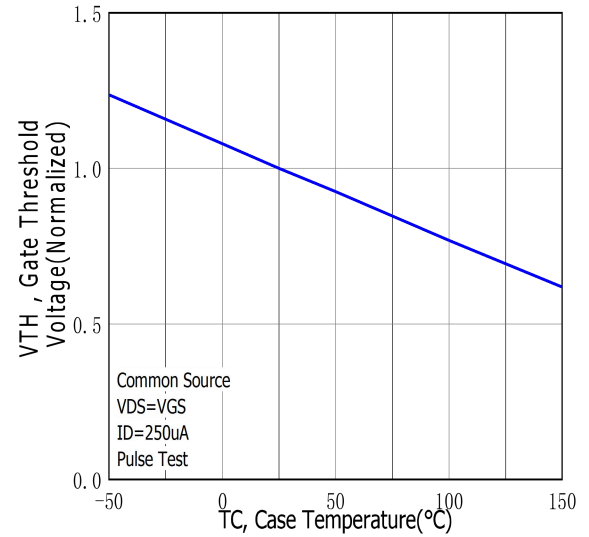

Figure.11 Maximum Effective Thermal Impedance, Junction to Case

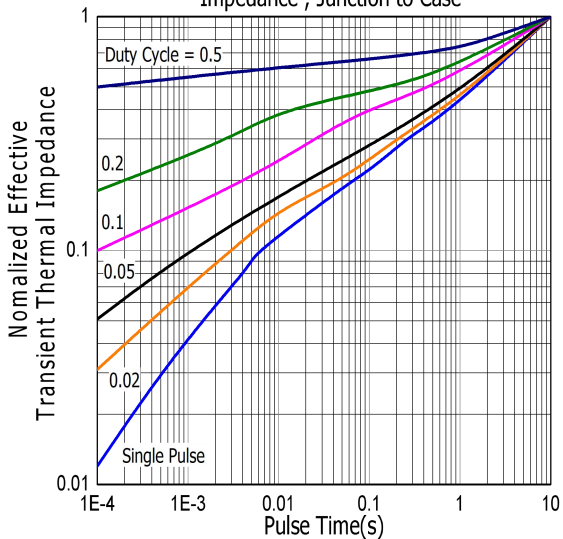
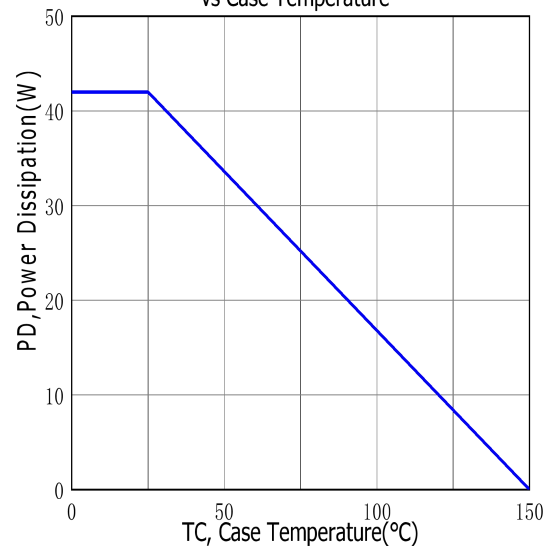
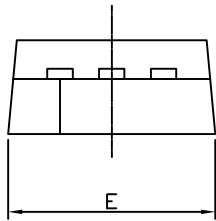
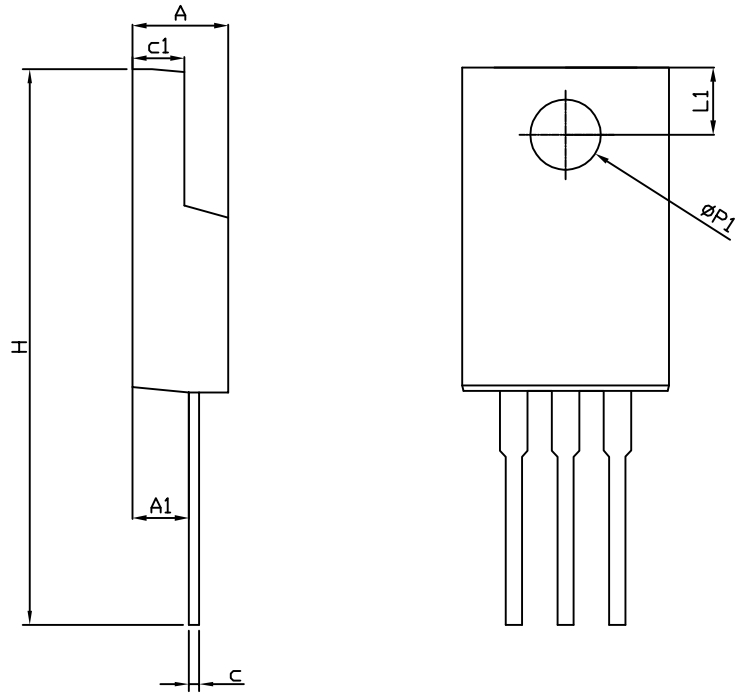
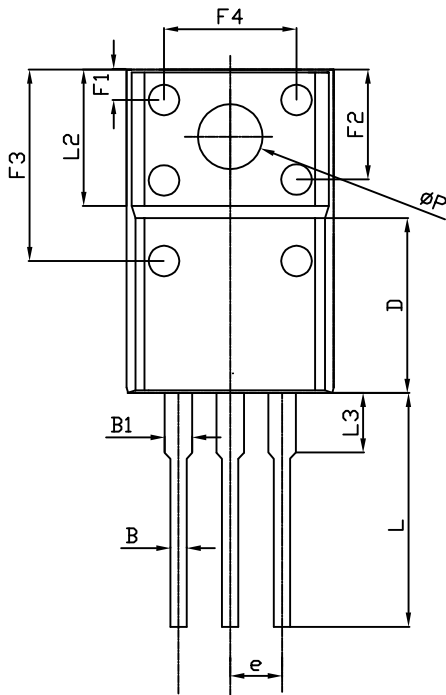

Figure.12 Maximum Power Dissipation vs Case Temperature



# TO-220F-3L PACKAGE OUTLINE



RECOMMENDED LAND PATTERN

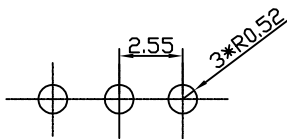

UNIT: mm

	MIN	NOM	MAX
A	4.40	4.60	4.80
A1	2.63	2.76	2.89
B	0.75	0.80	0.90
B1	1.12	1.27	1.42
c	0.40	0.50	0.60
c1	2.60	2.70	2.80
D	7.50	7.80	8.10
e	-	2.55REF	-
E	9.86	10.00	10.10
F1	1.90	2.12	2.40
F2	5.00	5.30	5.65
F3	8.70	9.00	9.30
F4	6.20	6.50	6.80
H	27.80	28.30	28.80
L	13.10	13.30	13.50
L1	2.85	3.00	3.15
L2	-	6.70REF	-
L3	2.80	3.10	3.40
$\Phi P$	3.00	3.30	3.60
$\Phi P1$	2.80	3.10	3.40